

EE-SX1330-2

Photomicrosensor (Transmissive)

Ultra-Compact Slot/SMD Type (Slot width: 3mm)

- High-speed response type with 50% less rise time than conventional products
Contributes to high-speed response and low power consumption in a wide range of applications

 Be sure to read Safety Precautions on page 3.



Part Number Structure

EE-SX □ □ □ 0-2
(1)(2)(3)(4)

- | | | | |
|---------------------------------------|--|---------------------------------|--------------------------------|
| (1) Sensing method
X: Transmissive | (2) Output type
1: Phototransistor output | (3) Connecting method
3: SMT | (4) Sensing distance
3: 3mm |
|---------------------------------------|--|---------------------------------|--------------------------------|

Ordering Information

Photomicrosensor

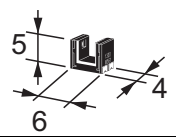
Appearance	Sensing method	Connecting method	Sensing distance	Aperture size (H × W) (mm)	Output type	Model
	Transmissive (slot type)	SMT	3 mm (slot width)	Emitter 1.4 × 1.4 Detector 1 × 0.3	Phototransistor	EE-SX1330-2

Ratings, Characteristics and Exterior Specifications

Absolute Maximum Ratings (Ta = 25°C)

Item	Rated value	Unit
Emitter		
Forward current I_F	25 *1	mA
Pulse forward current	100 *2	mA
Reverse voltage V_R	5	V
Detector		
Collector-Emitter voltage	12	V
Emitter-Collector voltage	5	V
Collector current	20	mA
Collector dissipation	75 *1	mW
Operating temperature	-30 to +85 *1	°C
Storage temperature	-40 to +90 *1	°C
Reflow soldering temperature	255 *3	°C

- *1. Refer to the temperature rating chart if the ambient temperature exceeds 25°C.
*2. Duty ratio: 1%, Pulse width: 0.1 ms.
*3. Complete soldering within 10 seconds for reflow soldering.

External Specifications

Connecting method	Weight (g)	Materials
		Case
SMT	0.2	PPS

Electrical and Optical Characteristics (Ta = 25°C)

Item	Value			Unit	Condition
	MIN.	TYP.	MAX.		
Emitter					
Forward voltage	---	1.1	1.3	V	$I_F = 5 \text{ mA}$
Reverse current	---	---	10	μA	$V_R = 5 \text{ V}$
Peak emission wavelength	---	940	---	nm	$I_F = 20 \text{ mA}$
Detector					
Light current	200	---	1,000	μA	$I_F = 5 \text{ mA}$, $V_{CE} = 5 \text{ V}$
Dark current	---	10	100	nA	$V_{CE} = 10 \text{ V}$
Collector-Emitter saturated voltage V_{CE}	---	0.1	0.4	V	$I_F = 20 \text{ mA}$, $I_L = 100 \mu\text{A}$
Peak spectral sensitivity wavelength	---	900	---	nm	$V_{CE} = 5 \text{ V}$
Rise time	---	7	---	μs	$V_{CC} = 5 \text{ V}$, $R_L = 100 \Omega$, $I_L = 500 \mu\text{A}$
Fall time	---	11	---	μs	$V_{CC} = 5 \text{ V}$, $R_L = 100 \Omega$, $I_L = 500 \mu\text{A}$

Note: Refer to the following timing diagram for t_r and t_f .

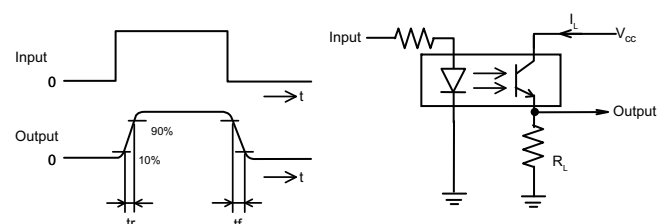

Engineering Data (Reference value)

Fig 1. Forward Current vs. Collector Dissipation Temperature Rating

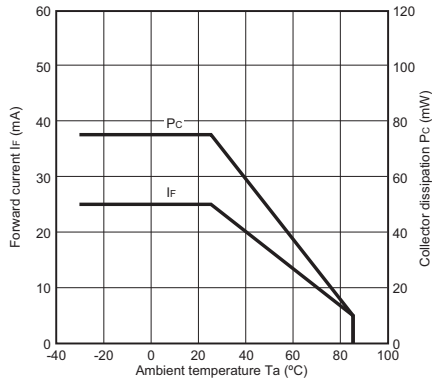

Fig 2. Forward Current vs. Forward Voltage Characteristics (Typical)

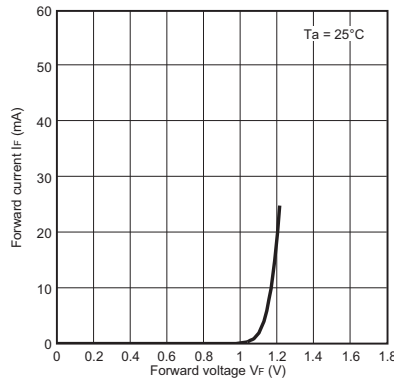

Fig 3. Light Current vs. Forward Current Characteristics (Typical)

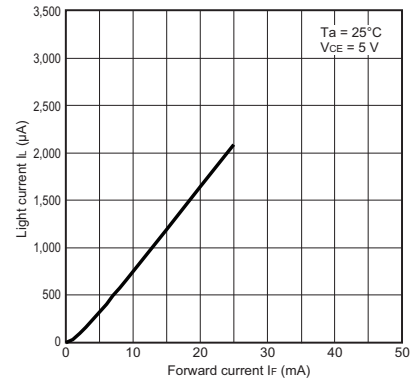

Fig 4. Light Current vs. Collector-Emitter Voltage Characteristics (Typical)

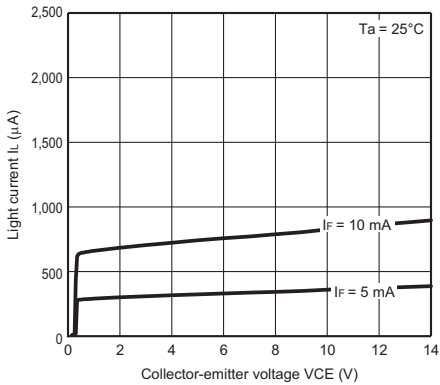

Fig 5. Relative Light Current vs. Ambient Temperature Characteristics (Typical)

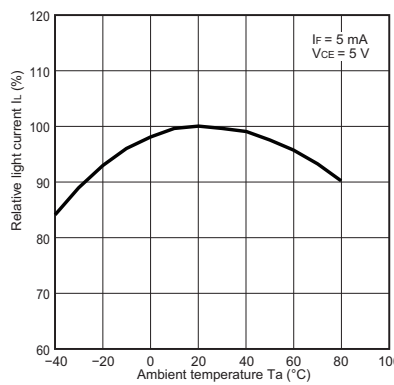

Fig 6. Dark Current vs. Ambient Temperature Characteristics (Typical)

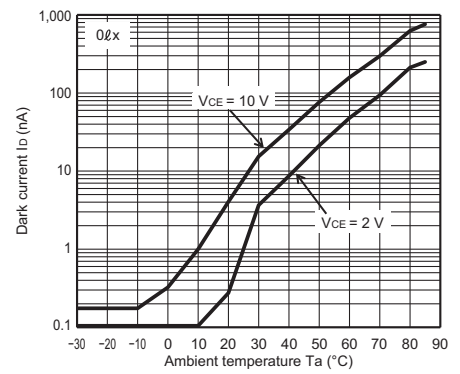

Fig 7. Rise time vs. Load Resistance Characteristics (Typical)

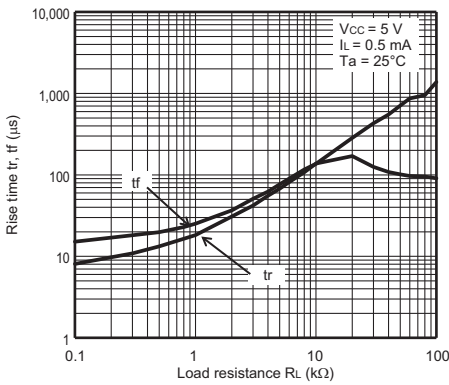

Fig 8. Sensing Position Characteristics (Typical)

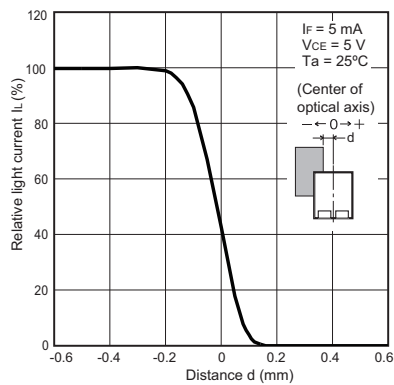
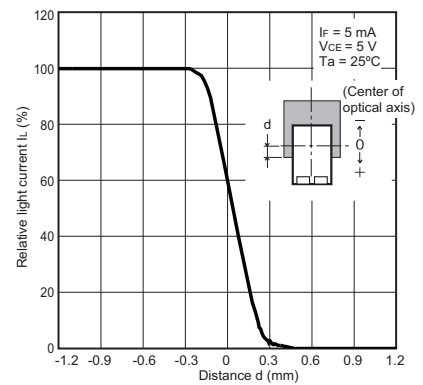

Fig 9. Sensing Position Characteristics (Typical)



Safety Precautions

To ensure safe operation, be sure to read and follow the Instruction Manual provided with the Sensor.

CAUTION

This product is not designed or rated for ensuring safety of persons either directly or indirectly. Do not use it for such purposes.



Precautions for Safe Use

Do not use the product with a voltage or current that exceeds the rated range.

Applying a voltage or current that is higher than the rated range may result in explosion or fire.

Do not miswire such as the polarity of the power supply voltage.

Otherwise the product may be damaged or it may burn.

This product does not resist water. Do not use the product in places where water or oil may be sprayed onto the product.

Precautions for Correct Use

Do not use the product in atmospheres or environments that exceed product ratings. This product is for surface mounting. Refer to Soldering Information, Storage and Baking for details.

Dispose of this product as industrial waste.

Dimensions and Internal Circuit

CAD Data marked products, 2D drawings and 3D CAD models are available. For CAD information, please visit our website, which is noted on the last page.

(Unit: mm)

Photomicrosensor

EE-SX1330-2

CAD Data

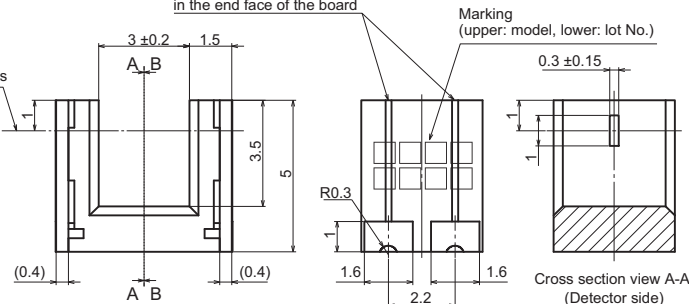
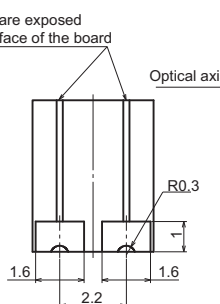
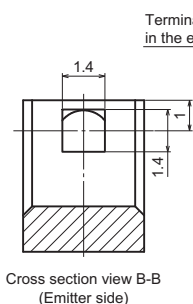
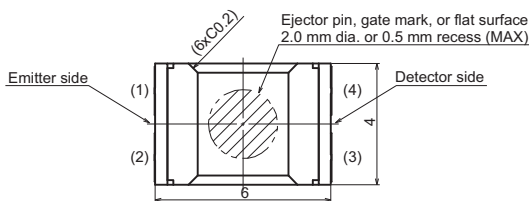

Aperture size (H x W)

Emitter	Detector
1.4×1.4	1×0.3

Internal circuit

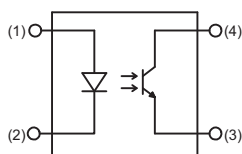

Terminal No.	Name
(1)	Anode
(2)	Cathode
(3)	Emitter
(4)	Collector

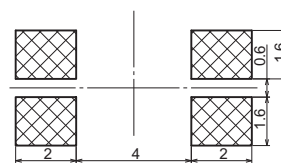

Unless otherwise specified, the tolerances are ±0.2 mm.

EE-SX1330-2

Tape and Reel

Reel (Unit: mm)

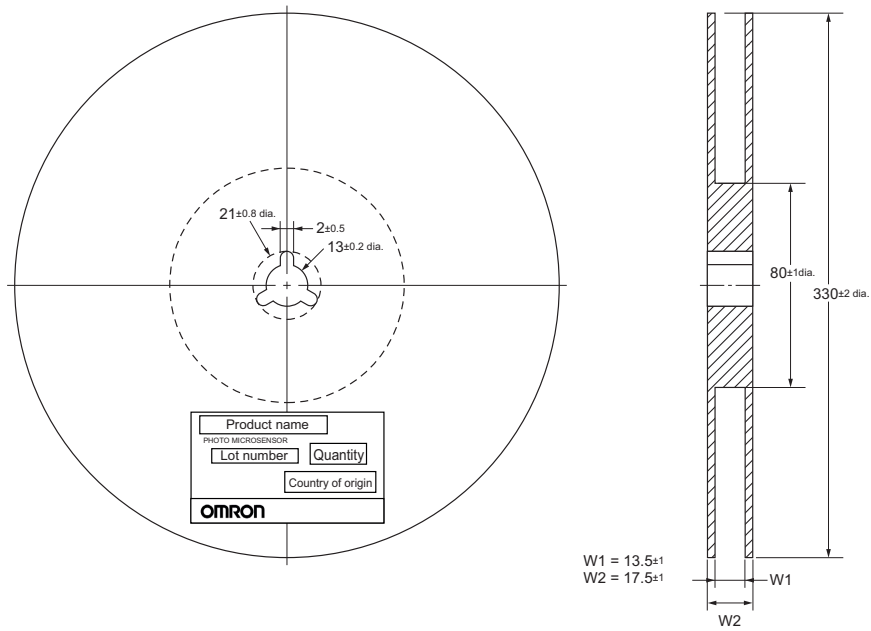

Tape (Unit: mm)

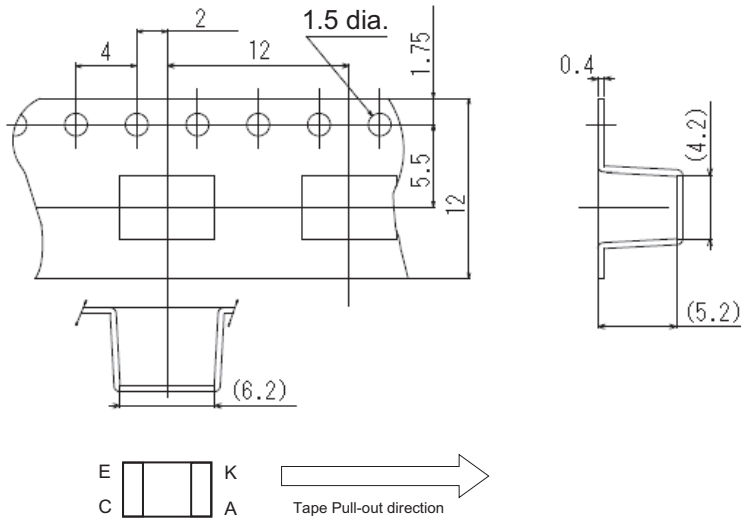

Note: Direction of product packing is upper figure.

Tape quantity

1,000 pcs./reel

Soldering Information

Reflow soldering: Temperature profile

1. The reflow soldering can be implemented in two times complying with the following diagram.
All the temperatures in the product must be within the diagram.
2. The recommended thickness of the metal mask for screen printing is between 0.2 and 0.25 mm.

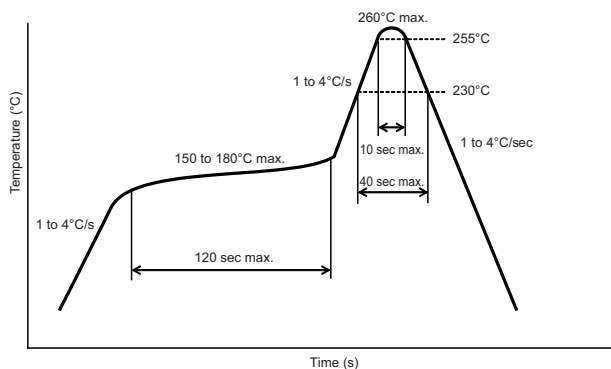

Manual soldering

The manual soldering should not be applied to the products, otherwise the housing may be deformed and/or the Au plating may be peeled off by heat.

Other notes

The use of infrared lamp causes the temperature at the resin to rise particularly too high.

All the temperatures in the product must be within the above diagram. Do not immerse the resin part into the solder. Even if within the above temperature diagram, there is a possibility that the gold wire in the products is broken in case that the deformation of PC board gives stress to the products.

Please confirm the conditions (including material and method of flux and cleaning) of the reflow soldering fully by actual solder reflow machine prior to the mass production use.

Storage

Storage conditions

To protect the product from the effects of humidity until the package is opened, dry-box storage is recommended. If this is not possible, store the product under the following conditions:

Temperature: 10 to 30 °C
Humidity: 60% RH max.

Treatment after open

1. Reflow soldering must be done within 48 hours stored at the conditions of humidity 60% RH or less and temperature 10 to 30°C.
2. If the product must be stored after it is unpacked, store it in a dry box or reseal it in a moisture-proof package with desiccant at a temperature of 10 to 30°C and a humidity of 60% RH or less. Even then, mount the product within one week.

Baking

In case that it could not carry out the above treatment, it is able to mount by the following baking treatment. However baking treatment shall be limited only 1 time.

Recommended conditions: 60°C for 24 to 48 hours (reeled one)
100°C for 8 to 24 hours (loose one)

Please check each region's Terms & Conditions by region website.

OMRON Corporation

Device & Module Solutions Company

Regional Contact

Americas

<https://components.omron.com/us>

Asia-Pacific

<https://components.omron.com/ap>

Korea

<https://components.omron.com/kr>

Europe

<https://components.omron.com/eu>

China

<https://components.omron.com.cn>

Japan

<https://components.omron.com/jp>